

TECHNICAL SPECIFICATION

Competition long jump and triple jump take-off board set with stainless steel foundation tray lowered edges and wooden base board

S-250 (ver. 2017)

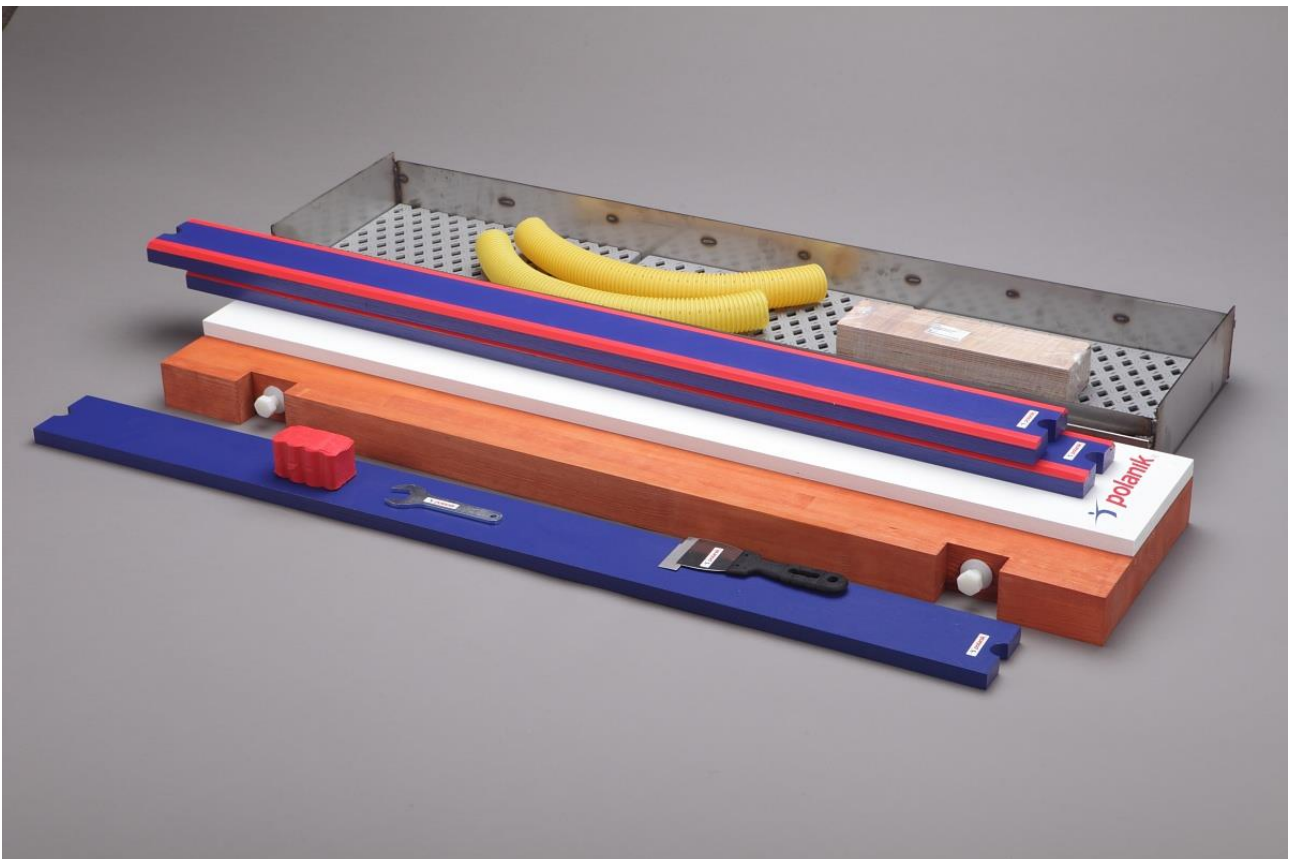

SAFER JUMPS TECHNOLOGY



I. General characteristics

The take-off board S-250 is designed for conducting sports events and training programs of horizontal jumps.
Main features of the take-off board:









- construction according to the latest safety recommendations – no metal elements in take-off zone, so foundation tray with lowered edges covered by synthetic surface and white take-off board fastened from the bottom side, no screws on top



- innovative construction – constituted by elements which are easy to assemble, transport and store
- easy operating – fast assembly and disassembly processes, which take 15 minutes approx., can be done by one person provided that the foundation tray is already embedded in the track,
- high durability and quality – foundation tray made of stainless steel does not require additional maintenance actions, other elements are made of plastic, waterproof plywood and impregnated wood, the take-off board meets the international quality standards
- fast replacement of wearing parts and elements



II. Parts list (part sets)

Item	Part/set description	Q-ty pcs	Part/set sketch
1	Stainless steel foundation tray (lowered edges) with accessories for concreting (draining tubes and spacing boards) K3-250	1	
2	Wood base board S-250-01-01	1	
3	White take-off board with screws K1-250	1	
4	Indicator plasticine board S-250-02-00	2	
5	Training indicator board without plasticine S-250-02-03	1	
6	Plasticine 300 g S-250-02-01	1	
7	Plasticine forming knife S-250-06-00	1	
8	Wrench - to block board in the tray S-0250-000-00-08-00	1	
9	Draining plastic grid S-250-03-00	3	

III. Technical data

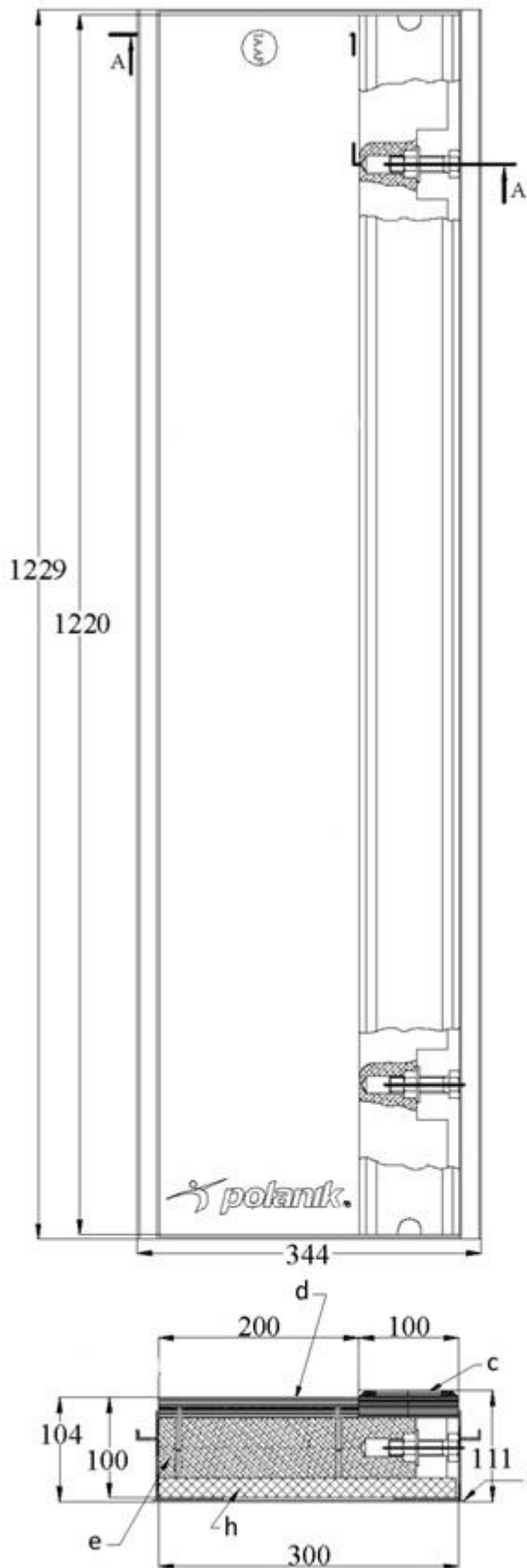

Product code	S-250
Description	set of take-off board for long and triple jump
Type	competition, IAAF certified
Use	ready set to be installed in long and triple jump runway
Foundation tray	stainless steel, lowered edges to be covered by synthetic surface for safety, equipped with drainage tubes and spacing boards
Base board	wooden, multilayer, impregnated, equipped with plastic blocking screws
White take-off board	beech glulam, painted, reversible, fastened to base board from bottom side for safety
Plasticine indicator board	waterproof plywood, painted, with two plasticine stripes
Training indicator board	waterproof plywood, painted
Spare plasticine	included
Forming knife	included
Wrench for blocking board inside tray	included
Way of packing	carton box
Box contents	1 set of S-250
L box length [mm]	1225
B box width [mm]	380
H box height [mm]	172
Gross weight [kg]	31



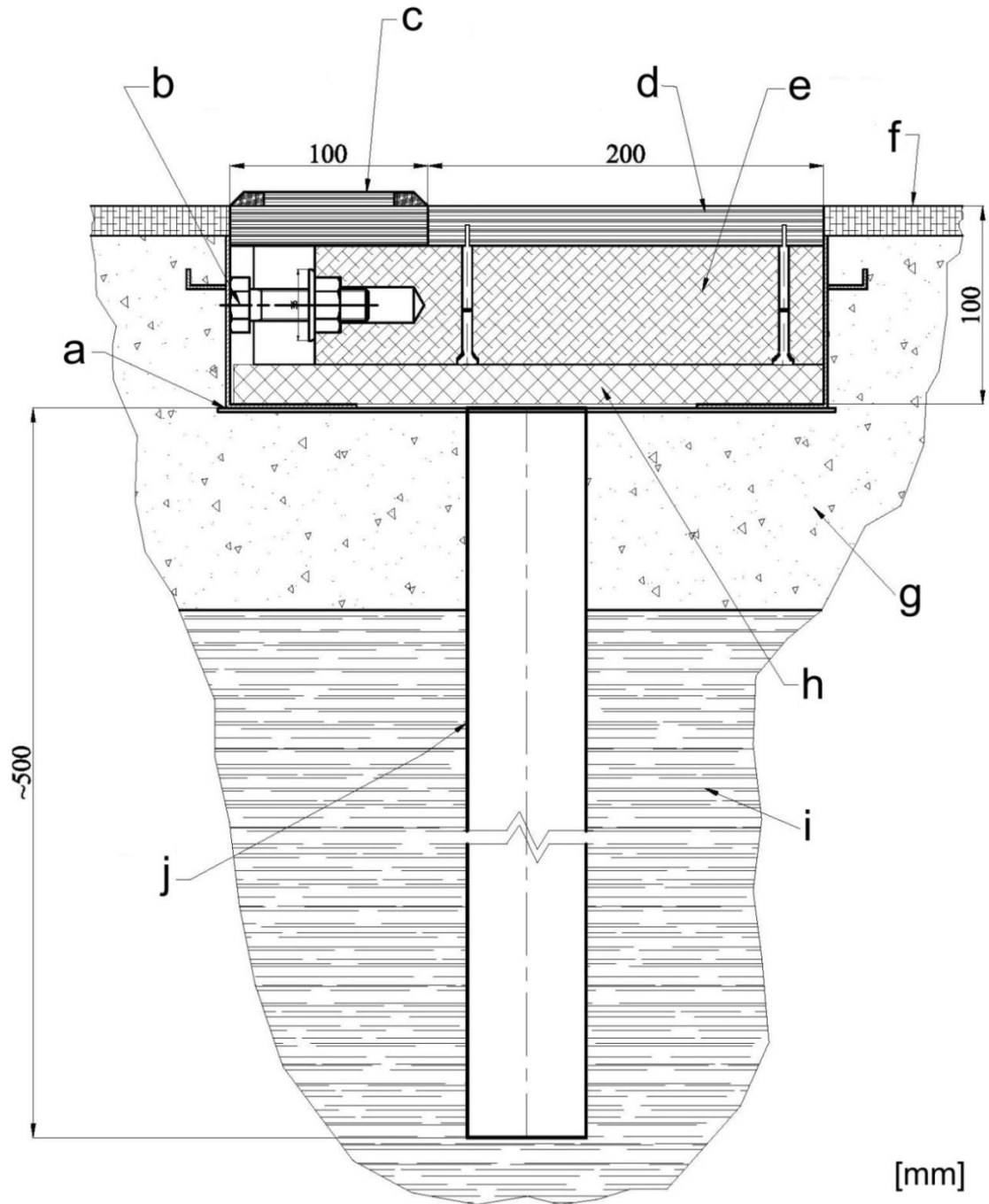

- a – stainless frame (item 1)
- c – plasticine indicator board (item 4)
- d – white take-off board (item 3)
- e – wooden base board (item 2)
- h – draining plastic grid (item 9)

IV. Technical drawing - installed take-off board



- a – stainless steel tray (item 1)
- b – adjusting bolt
- c – plasticine indicator board (item 4)
- d – white take-off board (item 3)
- e – wooden base board (item 2)
- f – athletics synthetic surface
- g – concrete
- h – plastic grid (item 9)
- i – ground
- j – draining tube

V. Additional equipment, available separately

Item	Part/set description	Part/set sketch
1	<p>Stainless steel cover for competition take-off board PBN-S0250</p> <p>Stainless steel cover for take-off competition boards, secures the inside of the board tray, smooth surface and 6 adjustable feet (in the range of 20 mm) for installing synthetic track, strong ribbed construction. Designed for sticking tartan.</p>	
2	<p>Stainless steel cover with edges for competition take-off board PBN14-S0250</p> <p>Stainless steel cover for take-off competition boards, secures the inside of the board tray, special edges for installing synthetic surface, 6 adjustable feet (in the range of 20 mm), strong ribbed construction, equipped with edges to facilitate application of tartan.</p>	
3	<p>Plasticine straps for indicator board P8x31</p> <p>Set of 8 red plasticine straps, specially shaped, ready to be put into the indicator board recess, designed for Polanik competition take-off boards</p>	
4	<p>Rubber indicator board for competition board LG15-250</p> <p>black full rubber indicator board designed for training</p>	

VI. IAAF certificate

International Association of Athletics Federations



Product Certificate

*The IAAF is pleased to certify hereby
that the following product:*

Product's Trade Name:
Fixed equipment, Take-off board, Competition

Description, Colour / Absolute Thickness:
Wood/plywood, White/dark blue

Company Name, Country:
Polanik Sp. z o. o. - Sp. K., POL

Catalogue Number:
S-250

IAAF Certification Number:
E-06-0433

meets the dimensional requirements for use in all international athletics competitions.

It is for the purchaser to determine the item's fitness for the purpose based on his knowledge of the local conditions and use.

Valid from:
1 May 2018

Until the last day of:
May 2022

This certificate is issued in accordance with the terms and conditions of the IAAF Certification System of track and field facilities, implements and competition equipment.



SEBASTIAN COE
IAAF President



JORGE SALCEDO
IAAF Technical Committee Chairman

