

Technical Specification Instruction manual

Pole vault competition landing area

T-8568



File: 2016-08-31

Product support
Paweł Ciechanowski
p.ciechanowski@polanik.com

Thank you for choosing POLANIK landing area.

Safe assembly and use

- **ATTENTION! VACCU M PACKED PRODUCT – UNPACK IMMEDIATELY AFTER DELIVERY**
- Before you start to assemble and use the landing area please read this manual carefully and store the manual in a safe place for further reference. Polanik Sp. z o. o. shall not be liable for any cage damages which are the result of the failure to follow this manual.
- Unauthorized copying of this manual, in whole or in part, is prohibited.
- The contents of this manual are subject to change without notice.
- Warning! The sports equipment produced by Polanik Sp. z o. o. is designed for athletics training and use in sports competitions only. Please pay special attention when using the product, misuse of athletics equipment can cause serious injury or in extreme cases even death. That is why training and use during sports events have to be always supervised by authorized sports personnel. In no event shall Polanik Sp. z o. o. be liable for any special, incidental, indirect or consequential damages in connection with the purchase or use of POLANIK products or costs over the original cost of the product.
- Specific warranty terms:
 - 1) The use of the landing area outdoors requires a waterproof cover and a landing area platform for proper insulation from the ground. Failure to follow the above restrictions results in the loss of the warranty rights.
 - 2) The top pad of the landing area is equipped with a spike resistant mesh fabric. The mesh fabric is designed to protect the landing area against spikes used by jumpers. While landing and walking on the top pad the spikes go through the mesh fabric and do not damage the surface. One must not shuffle the spikes on the mesh fabric, because under high crosswise stress caused by moving the spikes without lifting the feet, it may happen that the top pad will be torn. The damages of the top pad caused by careless sliding the pikes on the top pad surface are excluded from the warranty and can be removed in course of payable repair or replacement of the landing area elements.

Contents

Chapter	Page
I. General description and use	3
II. Technical data	4
III. Packing and transport	6
IV. Preparing for first use	6
V. Assembly	7
VI. Operating	8
VII. Maintenance	8
VIII. Storing	8
IX. Declaration	9
X. IAAF certificate	10

I. General description and use

POLANIK landing area T-8568 is the top quality sports equipment which is designed to secure jumpers and absorb impact energy of a jumper's landing after take off and flight in pole vault competition and training. Main features:

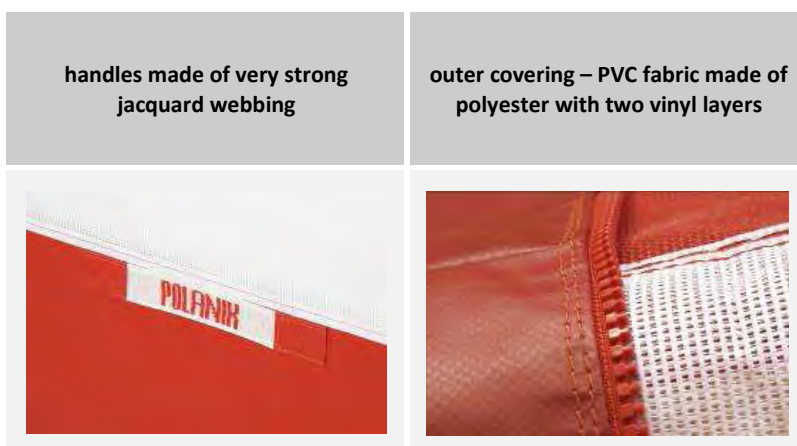
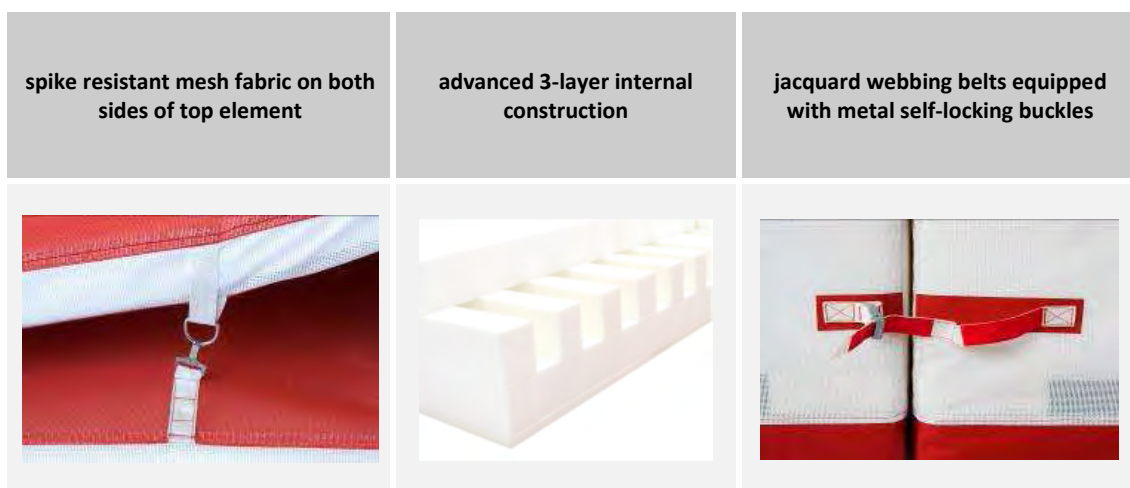
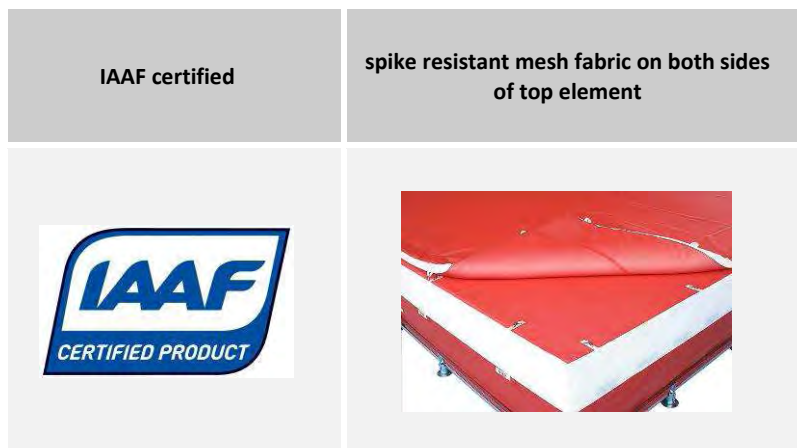

II. Technical data

Code	T-8568
Type	competition, certified, pole vault, type 11 of EN 12503-2
Dimensions length/ width/ height [m]	8,5 / 6 / 0,8
Net weight [kg]	640
Number of segments [pcs]	15
Spike resistant surface	upper and bottom side of top segment fastened to landing area with stainless steel hooks and D-rings
Segment outer covering	PVC fabric made of polyester with two vinyl layers
Internal segment construction	advanced 3-layer, air chamber, made of high quality PUR foam
Way of segment linking	jacquard webbing belts equipped with metal self-locking buckles
Way of waterproof cover fastening	metal hooks and D-rings
Handles	handles made of very strong jacquard webbing, strong envelope stitching

T-8568

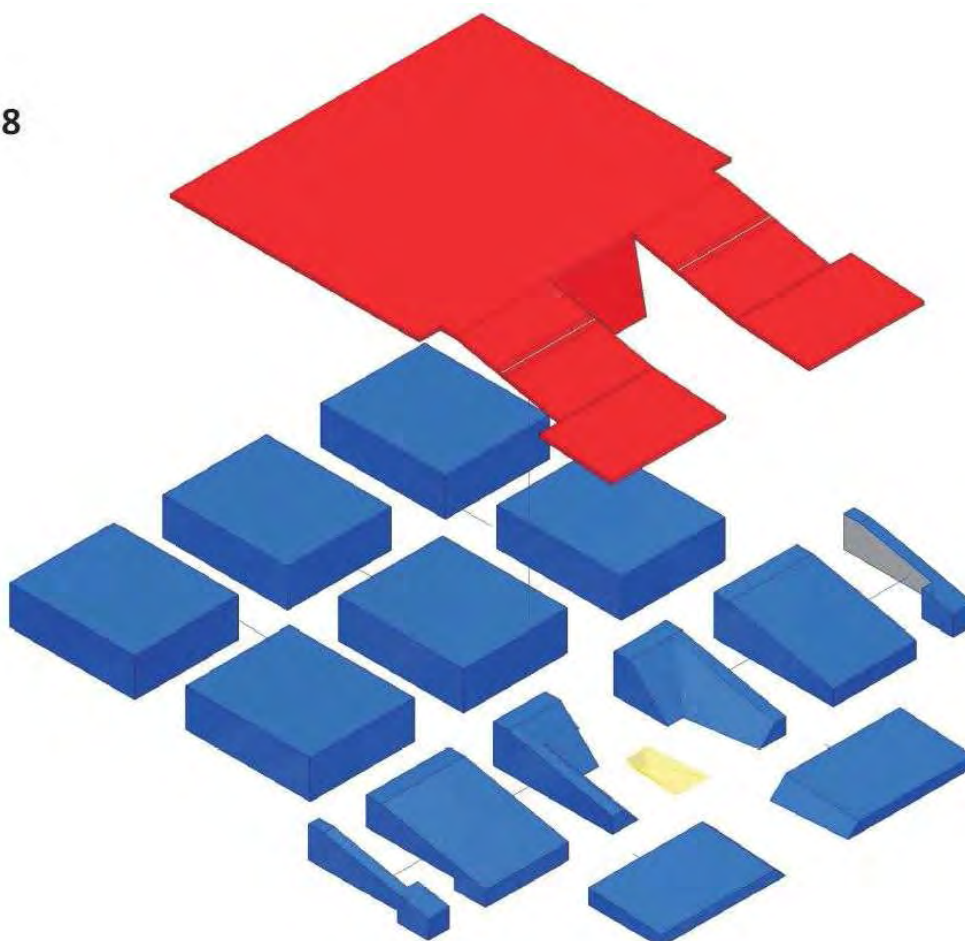

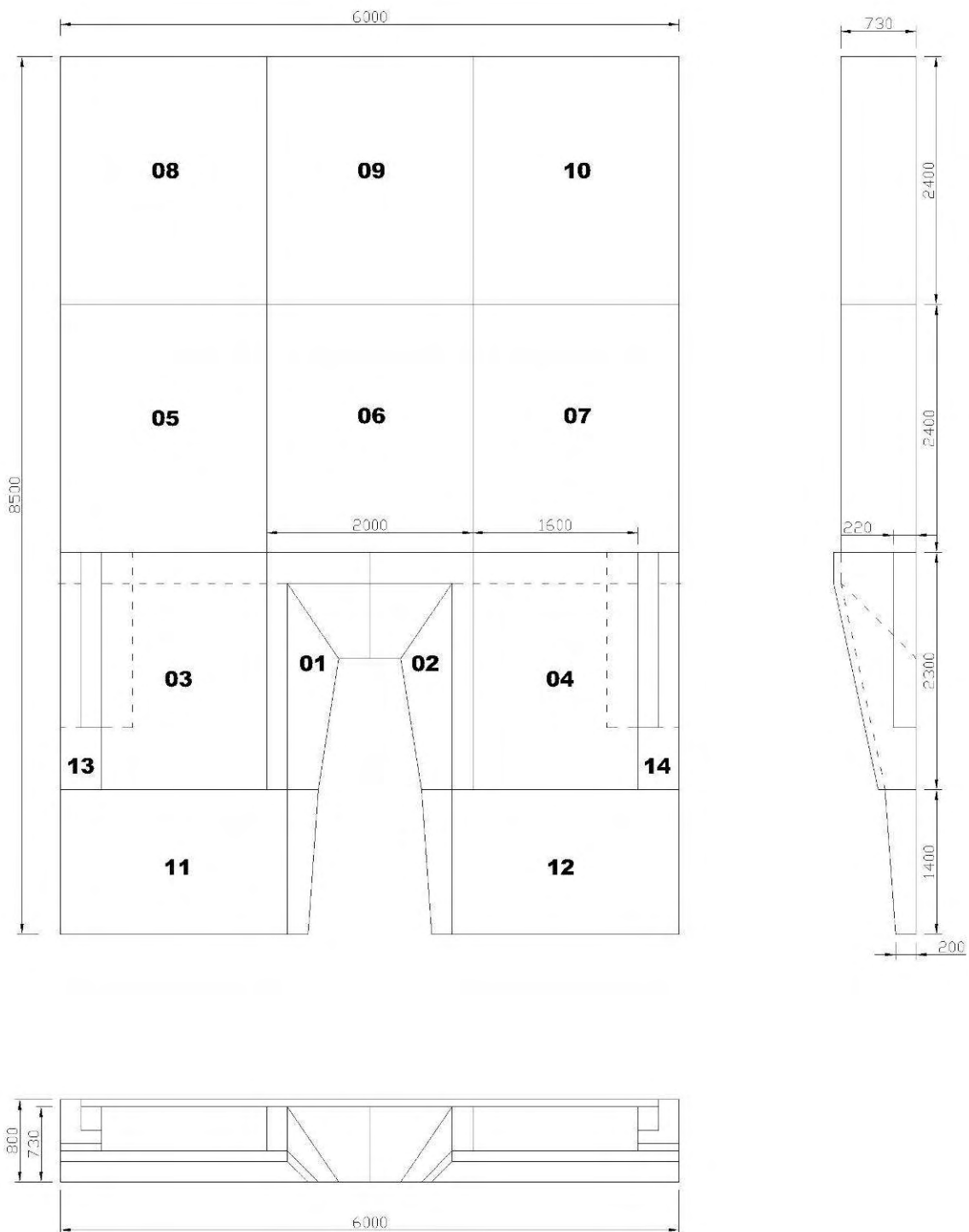

Dimensions [mm]

III. Packing and transport

The dimensions* of the vacuumed packed landing area segments:					
Seg. no.	Description	Weight [kg]	length L [m]	width B [m]	height H [m]
01	pole vault box surrounding pad left	19	1,30	0,70	0,70
02	pole vault box surrounding pad right	19	1,20	0,60	0,60
03	Wedge panel	39	1,70	0,70	0,70
04	Wedge panel	39	1,60	0,70	0,70
05	Main segment	64	2,00	0,70	0,70
06	Main segment	65	2,00	0,70	0,70
07	Main segment	64	2,00	0,80	0,80
08	Main segment	65	2,00	0,80	0,80
09	Main segment	64	2,00	0,70	0,70
10	Main segment	65	2,00	0,70	0,70
11	Front panel	19	1,40	0,60	0,60
12	Front panel	18	1,40	0,50	0,50
13	Side panel	20	2,40	0,75	0,65
14	Side panel				
15	Top spike resistant pad	100	2,00	0,80	0,80
Total volume [m³]			12,47		
Total gross weight [kg]			660		

*Please note that the dimensions can differ from the above table in the range of +/- 7%.

IV. Preparing for first use

The landing area segments are vacuum packed only for transport. Please unpack them immediately after delivery and leave them in a roofed place for few hours, so that they can return to their original shapes. **Storing vacuum packed landing area segments may cause permanent damages in their internal structures.** When the landing area elements return to their original dimensions, you can place them in a pole vault field. The field surface should be even, smooth and without any obstacles. If you use the landing area outdoors, you should also provide: a special waterproof cover P-8568 to protect the landing area against unfavourable weather conditions and a modular platform ST-8,5x6 to insulate the landing area from the ground.

V. Assembly

To assemble the landing area please follow the below steps:

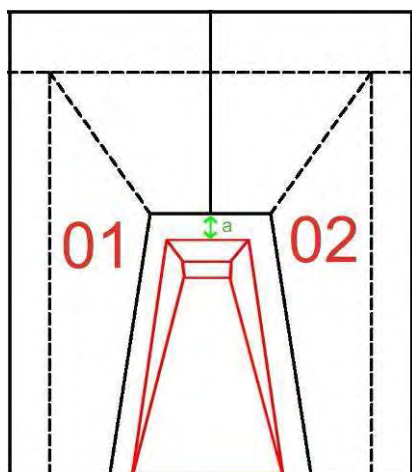

place the pole vault box surrounding pads (01 and 02) around the pole vault box, so as the distance between the rear edge of the box and the landing area pads (a) is 15 cm, make sure that all the Velcro® pads adjoin properly, next attach wedge panels 03 and 04, front panels 11 and 12, then side panels 13 and 14;



now the main segments 05, 06 and 07 should be linked to the rest of the segments using the jacquard webbing belts and self-locking buckles located on the segment sides, do the same with the segments 08, 09 and 10;

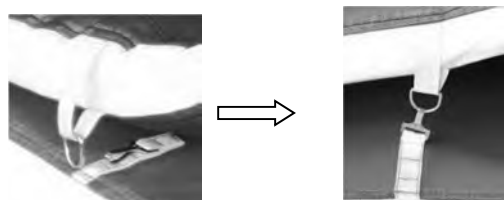

last step is to place the top pad 15 on the landing area and fasten it to the segments using the snap hooks and D-rings, now the landing area is ready for use.

VI. Operation

Stepping on the landing area and practising require special footwear designed for those purposes. Treading on the landing area in footwear with spikes is only allowed when the landing area is equipped with special spike resistant surface. Stepping on the landing areas in hard footwear or in shoes with heels is strongly prohibited. You must not put any tables, chairs, benches or any other objects whose unit pressure exceeds $1\text{kg}/1\text{cm}^2$ on the landing area. If the landing area is moved from one place to another very often, it is recommended that a landing area cart should be used.

VII. Maintenance

Due to the hygiene requirements it is recommended that the landing area should be cleaned regularly with commonly available detergents. Before you start wiping the landing area, please try to clean a small spot on its bottom side in order to check the reaction with the PVC fabric.

VIII. Storing

The landing area segments can be stored only in a horizontal position. They cannot be bent or pressed by any objects during storing. That may deform the segments permanently. A storing facility should be clean and dry. It ought to provide min. temperature 5°C .

Even the best technical solutions cannot substitute for common sense. The usage of the product must take place under the supervision of qualified coaches. The producer shall not be liable for any incidents caused by the improper assembly or its misuse. The producer reserves the right to introduce without warning changes in product constructions and colours.

IX. Declaration

- 1) No. 2016-08-31
2) Issuer's name: POLANIK
Issuer's address: Życzliwa 11, 97-300 Piotrkow Tryb.
3) Object of declaration:

Position	Description	Code
1	Competition pole vault landing area 8,5 x 6 x 0,8 [m]	T-8568

- 4) The object of declaration described above is in conformity with the requirements of the following documents:

Document No.	Title	Edition/Date of issue	Position
PN-EN 12503-2 type 11	Sports mats – Part 2: Pole vault and high jump mats, safety requirements	April 2004	All above

Additional Information

- 5) Declaration for:

BUYER and USER

Signed for and in behalf of:
POLANIK

2016-08-31 Piotrkow Tryb.
(Date and place of issue)

Pawel Ciechanowski
Product Manager

- 6)
(Name, function)

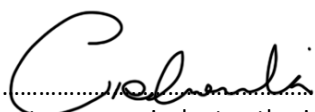
.....
(Signature or equivalent authorized by the issuer)

X. IAAF certificate



Product Certificate

The IAAF is pleased to certify hereby that the following product:

Product's Trade Name: Landing area, Pole Vault

Description, Colour / Absolute Thickness: 8.5m x 6m x 0.80m, Various

Company Name, Country: Polanik Sp. z o. o. - Sp. K., POL

Catalogue Number: T-8568

IAAF Certification Number: E-03-0360

meets the dimensional requirements for use in all international athletics competitions.

It is for the purchaser to determine the item's fitness for the purpose based on his knowledge of the local conditions and use.

Valid from: 1 June 2016

Until the last day of: June 2020

This certificate is issued in accordance with the terms and conditions of the IAAF Certification System of track and field facilities, implements and competition equipment.



SEBASTIAN COE
IAAF President



JORGE SALCEDO
IAAF Technical Committee Chairman

